

1

2

3

4

5

6

EDGE CONNECTION 1

J1
50 Pin Header

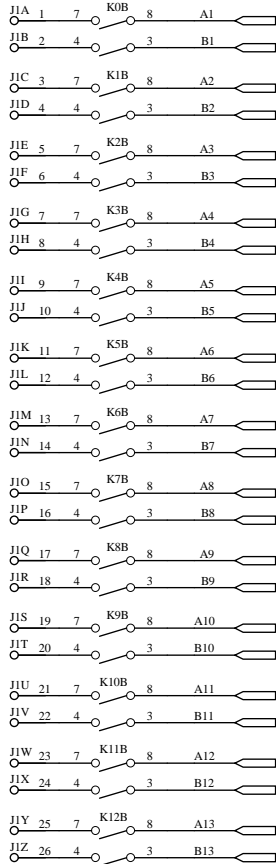

J2
50 Pin Header

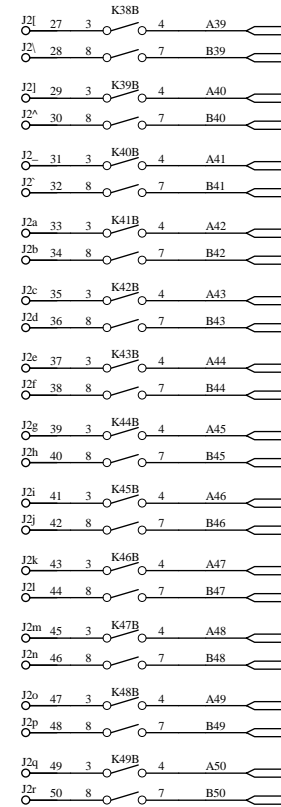
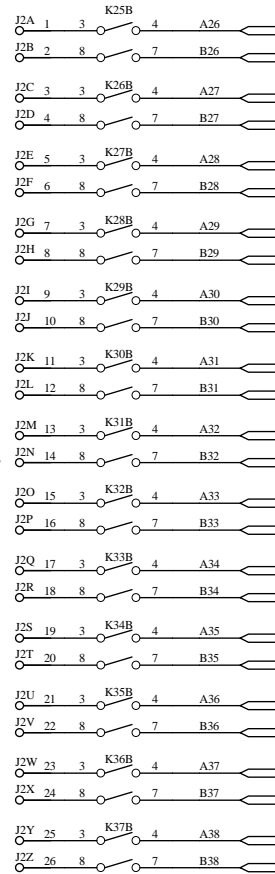
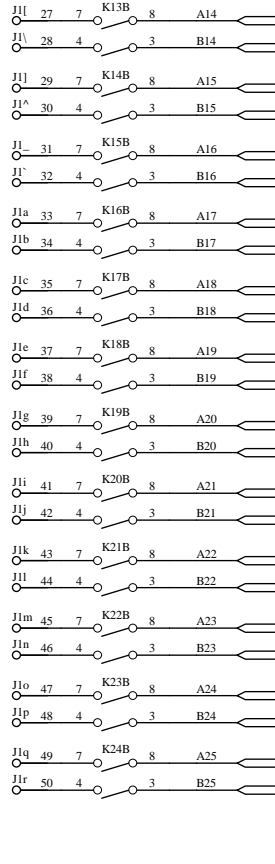

APPROVED BY	DRAWING NUMBER	DRAWN BY: KJA
DATE: 5-Feb-2009	34-02-50/1	REVISION:
SIZE: B	TITLE: GX/200 SWITCH MODULE	
34-02-50-01.sch		SHEET 1 OF 4

1

2

3

4

5

6

EDGE CONNECTION 2

J3
50 Pin Header

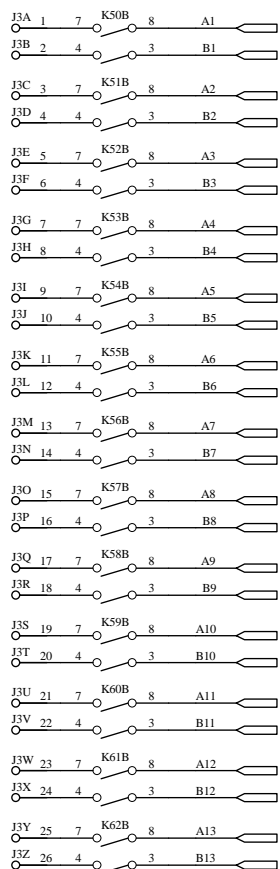

J4
50 Pin Header

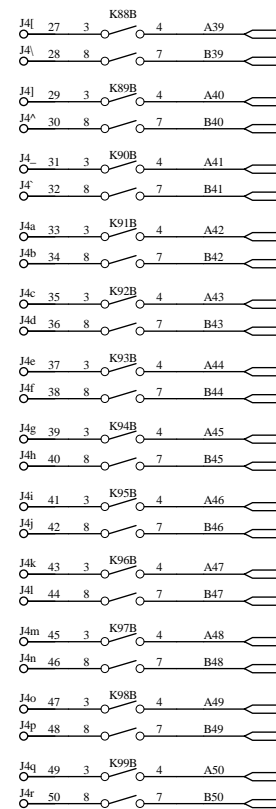
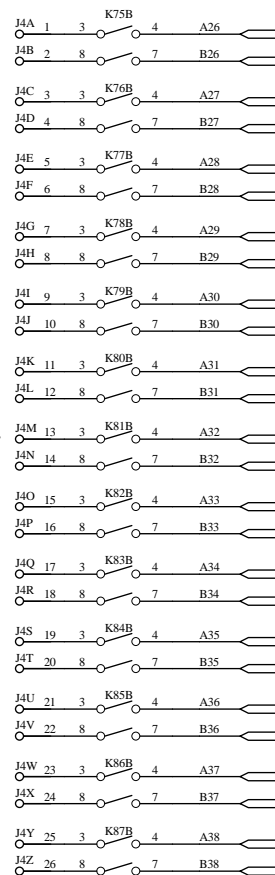
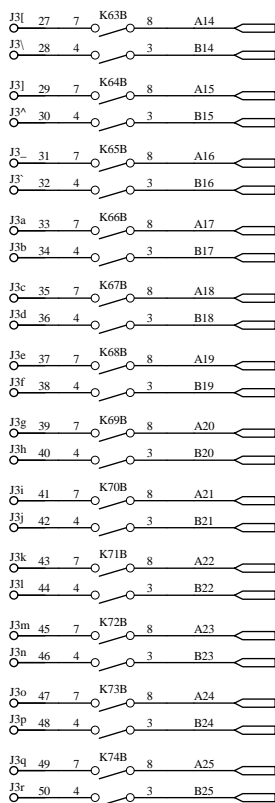

YTEC CORP.

APPROVED BY	DRAWING NUMBER	DRAWN BY: KJA
DATE: 5-Feb-2009	34-02-50/2	REVISION:
SIZE: B	TITLE: GX/200 SWITCH MODULE	
34-02-50-02.sch		SHEET 2 OF 4

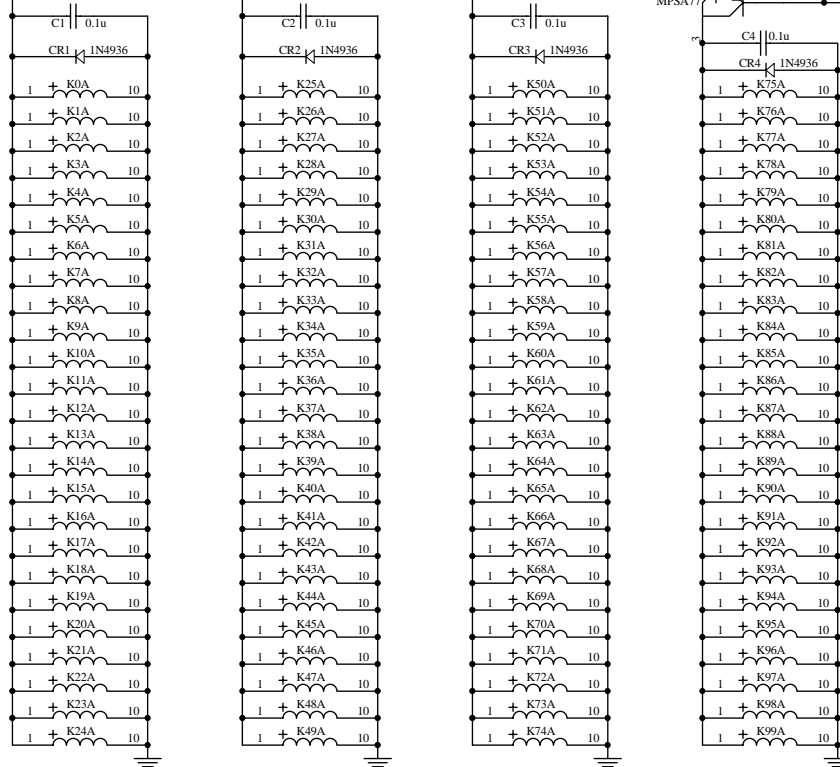
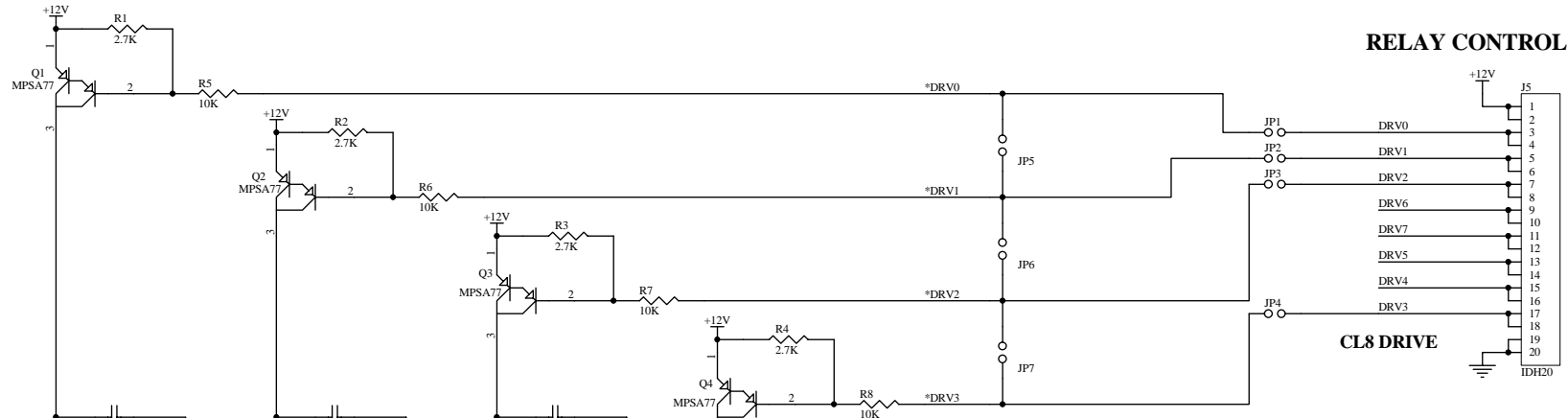

MODULE STYLE JUMPER CONFIGURATION

- 1X1-200**
 - 2(1x1)-100**
 - 4(1x1)-50**
- SHUNT JP1,JP5-JP7**
SHUNT JP1,JP3,JP5,JP7
SHUNT JP1-JP4

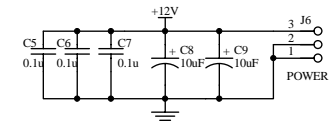

APPROVED BY	DRAWING NUMBER	DRAWN BY: KJA
DATE: 5-Feb-2009	34-02-50/3	REVISION:
SIZE: B	TITLE: GX/200 SWITCH MODULE	
34-02-50-03.sch		SHEET 3 OF 4

RELAY GNDS

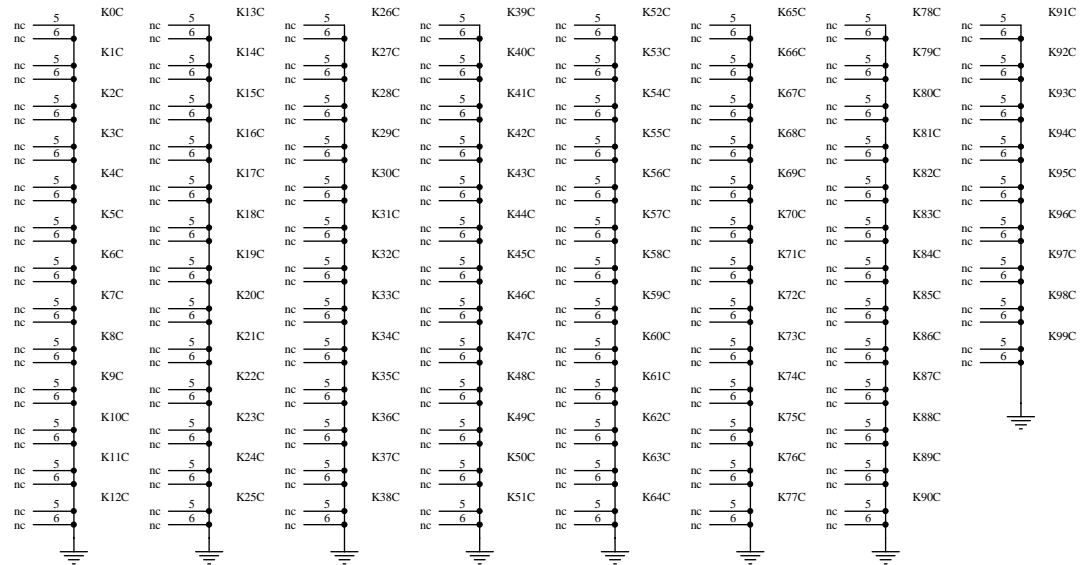

APPROVED BY	DRAWING NUMBER	DRAWN BY: KJA
DATE: 5-Feb-2009	34-02-50/4	REVISION:
SIZE: B	TITLE: GX/200 SWITCH MODULE	
34-02-50-04.sch		SHEET 4 OF 4