

J1 - RELAY DRIVE CONNECTION

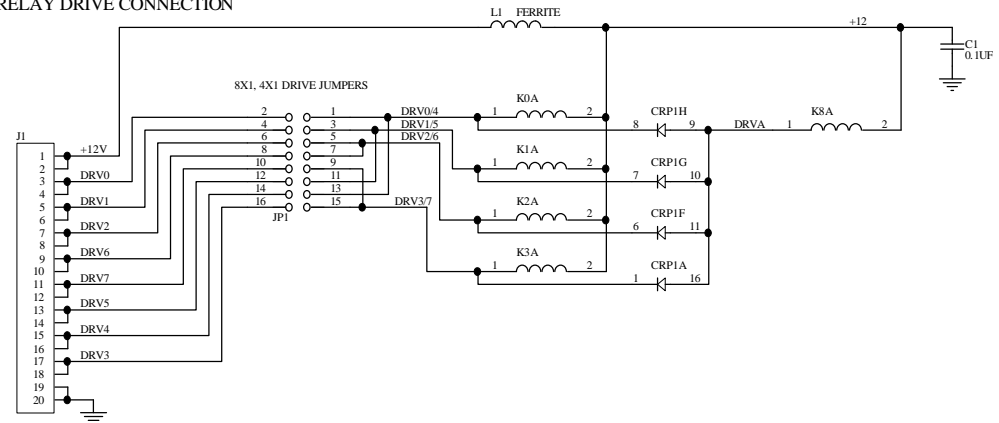

CHART

TYPE	RESISTOR	VALUE
T1K	R0-R3	1K
T50	R0-R3	49.9
T75	R0-R3	75

NOTES:
1. UNLESS OTHERWISE SPECIFIED ALL RESISTORS ARE IN OHMS.

REVISED FROM:2-442-2



APPROVED BY	DRAWING NUMBER	DRAWN BY: RHB
DATE: 4/14/2005	21-14-52	REVISION:
SIZE: A3	TITLE: CXR/4X1-1T SWITCH MODULE	
21-14-52	SHEET 1 OF 1	